

AVTREKKERE

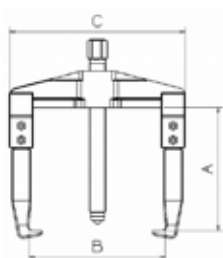
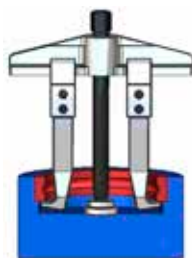

AVTREKKER 2-ARMET

BEST.NR.	A	B	C	
SMP-632410	100	95	134	1,1
SMP-632415	100	135	176	1,3
SMP-632420	150	160	223	3,5
SMP-632425	155	190	250	3,6
SMP-632430	205	240	325	7,5
SMP-632435	200	350	425	9,0
SMP-632440	200	510	585	15,0
	225	640	717	23,0

AVTREKKERSETT 2-ARMET

Leveres med stativ som avbildet

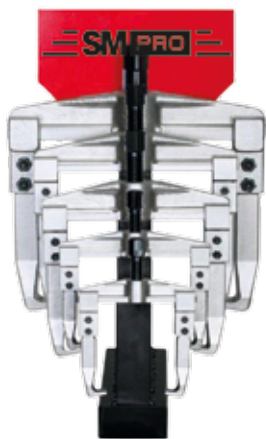

BEST.NR.	5 DELER	
SMP-632400	SMP-63 2410, SMP-632415, SMP-632420, SMP-632425, SMP-632430	20,1

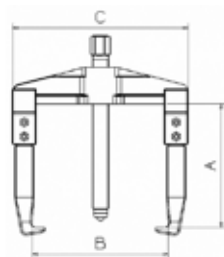
AVTREKKER 3-ARMET

BEST.NR.	A	B MAKS	B MIN	C	
SMP-642410	100	95	35	134	1,1
SMP-642415	100	135	38	176	1,3
SMP-642420	150	160	42	223	3,5

AVTREKKERBEN STANDARD OG LANGE

	PASSER TIL		LENGDE MM
SMP-633010	SMP-632410 / 632415 / 642410		90
SMP-633015	SMP-632410 / 632415 / 642415		200
SMP-633020	SMP-632420 / 632425 / 642420		150
SMP-633025	SMP-632420 / 632435 / 642420		300
SMP-633030	SMP-632430 / 632435 / 632440		200
SMP-633035	SMP-632430 / 632435 / 632440		375
	2450		
	2450L		

SPINDLER

BEST.NR.	R		C
SMP-633050	M14 x 1,50 x 158	SMP-632410 / 632415 / 642410/15	○ 17
SMP-633055	M20 x 1,50 x 235	SMP-632420 / 632425 / 642420	○ 22
SMP-633060	M28 x 2 x 310	SMP-632430 / 632435	○ 32
	1" gas x 11h. X 338	2440 ♦ -2450 ♦	○ 35

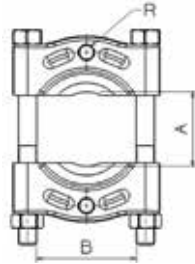
AVTREKKERPLATE

BEST.NR.	B	A MAKS	A MIN	R	⚖
SMP-651202	60	60	4	3/8"	0,7
SMP-651203	80	80	6	3/8"	1,3
SMP-651204	110	110	10	5/8"	2,7
SMP-651206	155	134	12	5/8"	5,7

BEST.NR.	LENGDE	BOLT MED 2 STK. MUTTERE
SMP-651302	130	For SMP-651202
SMP-651303	157	For SMP-651203
SMP-651304	210	For SMP-651204
SMP-651306	265	For SMP-651206

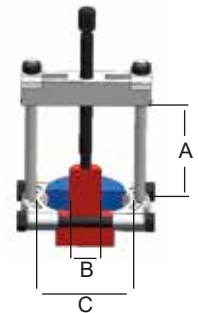
AVTREKKER FOR AVTREKKERPLATE

Illustrasjonsbilde med avtrekker montert på avtrekkerplate.

BEST.NR.	A	B	C	AVTREKKER FOR
SMP-651102	100	55	90	SMP-651202
SMP-651103	100	80	130	SMP-651203
SMP-651110	152	108	175	SMP-651204
SMP-651120	220	134	230	SMP-651206

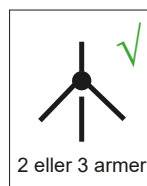
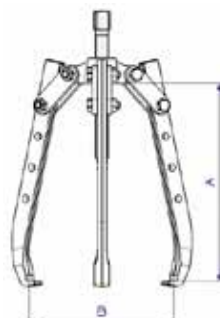
AVTREKKER 2/3-ARMET

BEST.NR.	A	B	⚖
SMP-677310	105	110	0,7
SMP-677315	185	175	1,9
SMP-677320	225	240	3,5
	225	290	3,9

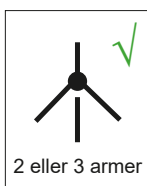
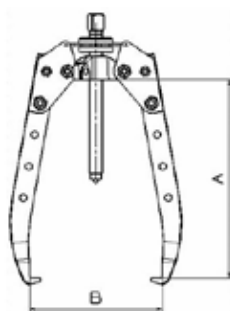
AVTREKKER 2/3-ARMET SELVSENTRERENDE

BEST.NR.	A	B		
SMP-677301	105	110	✓	0,8
SMP-677304	185	175	✓	1,9
SMP-677307	225	240	✓	6,5

- **Selvsentrerende:** Ved å flytte to bein følger det tredje med samtidig. Dette betyr at når du legger på press posisjoneres avtrekkeren seg i perfekt balanse (effektivt og brukervennlig)
- **2/3 ben:** Dette betyr at den kan brukes med 2 eller 3 ben
- **Låses ved maksimal åpning:** Er utformet på en slik måte at det ikke er mulig å overspenne armene. Gir maksimal sikkerhet.
- **Tynne ben:** Lettere å komme til på vanskelige steder (allsidighet for alle bransjer)
- **Ben med spor:** Bena har et spor som gjør det mulig å gripe en skrue (allsidighet)
- **3 høydejusteringer:** Avtrekkeren kan høydejusteres etter behov. Forhindrer spindelen å stikke ut med risiko for bøying (fleksibilitet, styrke og holdbarhet)

LAGERAVTREKKERE

BEST.NR.	Ø MM	
SMP-684305	5 - 7	0,1
SMP-684308	8 - 11	0,1
SMP-684312	12 - 14	0,3
SMP-684315	15 - 19	0,3
SMP-684320	20 - 24	0,3
SMP-684325	25 - 29	0,4
SMP-684330	30 - 37	0,4
SMP-684338	38 - 46	0,5
SMP-684347	47 - 54	1,3
SMP-684355	55 - 64	1,6
SMP-684365	65 - 76	2,0

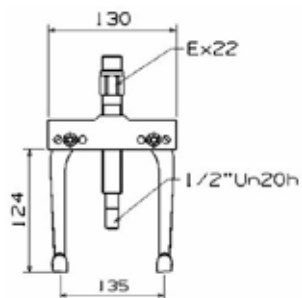
AVTREKKER FOR LAGERAVTREKKERE

BEST.NR.	
SMP-684392	1,5

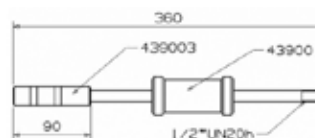
SLAGHAMMER FOR LAGERAVTREKKERE

BEST.NR.	
SMP-684390	1,4

AVTREKKERPLATE

BEST.NR.	SPENNVIDDE MM	BREDDE MM
KK-17-0	5-60	60
KK-17-1	12-75	75
KK-17-2	22-115	115
KK-17-3	25-155	155

TO-ARMEDE AVTREKKERE

BEST.NR.	BREDDE MM	LENGDE MM
KK-204-1	80	90
KK-204-2	100	100
KK-204-3	150	140

HYDRAULISK PRESSE

Settes mellom spindel og arbeidsstykket.
Passer alle typer avtrekkere.



BEST.NR.	HØYDE MM	TRYKK-LENGDE MM	MAKS TRYKK TONN
KK-9-1	62	10	10
KK-9-2	80	12	15

TO / TRE-ARMEDE AVTREKKERE

For små lagere, polsko, kabelsko etc.
Serie 42 er tre-armet.

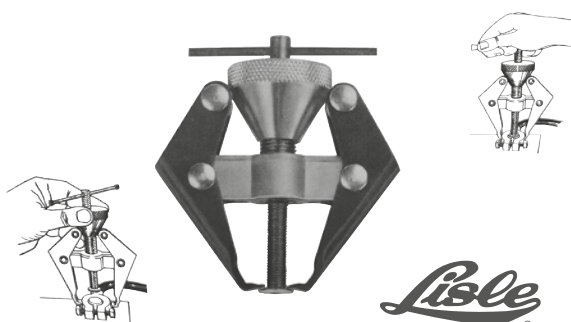

BEST.NR.	BREDDE MM	HØYDE MM
KK-41-1	65	65
KK-41-2	80	80
KK-42-1	65	65
KK-42-2	80	80

POLSKOAVTREKKER

L-54150

TO-ARMEDE AVTREKKERE

For små lagere, polsko etc.



BEST.NR.	BREDDE MM	HØYDE MM
KK-43-1	60	50
KK-43-2	70	70
KK-43-3	80	80
KK-43-11	60	50
KK-43-12	70	70
KK-43-13	80	80

AVTREKKERVERKTØY

SLAGHAMMERSETT FOR LAGERE

Leveres komplett med 2 og 3 armer for utvendig og innvendig bruk. Strammekonen sørger for at armene ikke glipper ved bruk.



BEST.NR.	KAPASITET	KAPASITET
CTA-8090	Med 2 armer innvendig 32 - 36 mm	Med 2 armer utvendig 25 - 114 mm
	Med 3 armer innvendig 33 - 121 mm	Med 3 armer utvendig 38 - 114 mm

PINNEBOLT AVTREKKERSETT

Leveres med piper for 6-8-10-12 mm. pinnebolter.



SMP-205585

DRIVLEDDAVTREKKER

Spesialavtrekker for fastsittende drivledd.
STOR TIDSBESPARING !

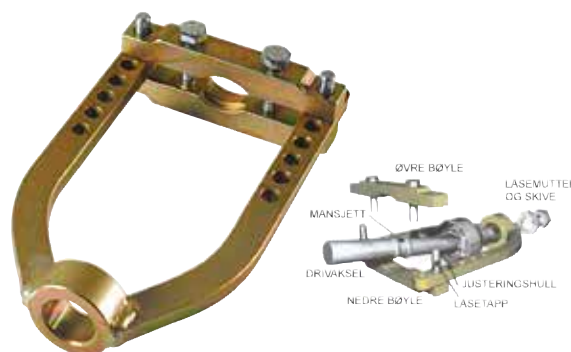

SMP-040250

PINNEBOLTAVTREKKERSETT

Helt ny type pinneboltavtrekkere hvor selve uttrekkerpipen er utformet slik at pinnebolten kan føres gjennom pipen. På denne måten er det ingen begrensning i hvor lang pinnebolten kan være. Leveres med piper for 6-8-10-12 mm. pinnebolter samt skrallenøkkel.



SMP-205595

MUTTERSPRENGERE HYDRAULISKE



BEST.NR.	FOR MUTTER
KK-56-1	7-22 mm
KK-56-2	22-36 mm

MUTTERSPRENGERE



BEST.NR.	FOR MUTTER MM
KK-55-0	4-10mm
KK-55-1	10-18mm
KK-55-2	19-27mm

AVTREKKERSETT



BEST.NR.	ISO LAGER BETEGNELSE	SPENNVIDDE
----------	----------------------	------------

SP-098000	6004 - 6010 - 6299 6205 - 6300 - 6302	20 - 95 mm
-----------	--	------------

SKRUEUTTREKKERSETT

BEST.NR.	ANTALL DELER	FOR SKRUER
----------	--------------	------------

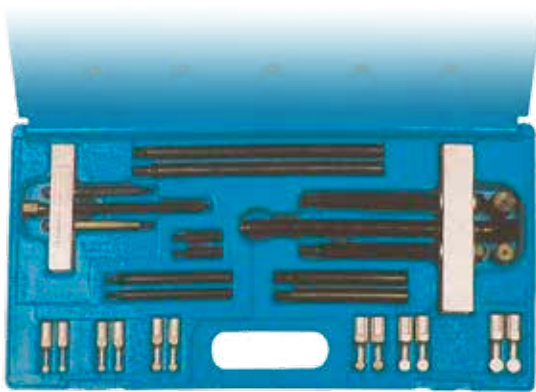
KD-720	5	4 - 16 mm
--------	---	-----------

AVTREKKERSETT

BEST.NR.	ISO LAGER BETEGNELSE	SPENNVIDDE
----------	----------------------	------------

SP-098100	6004 - 6015 - 6200 6211 - 6300 - 6307 6403 - 6404	20 - 117 mm
-----------	---	-------------

SKRUEUTTREKKERSETT

Effektivt for dimensjoner opp til 25mm.



BEST.NR.	INNHOOLD
----------	----------

SMP110000	25 deler M-5 - M-12, 5 spiralbor, 5 uttrekkere, 5 uttrekksmuttere, 10 borehylser
-----------	---

PINNEBOLT AVDRAGERE

BEST.NR.	FOR BOLT	BEST.NR.	FOR BOLT
----------	----------	----------	----------

SMP-205506	6 mm	100-014	1/4"
------------	------	---------	------

SMP-205508	8 mm	100-516	5/16"
------------	------	---------	-------

SMP-205510	10 mm	100-038	3/8"
------------	-------	---------	------

SMP-205512	12 mm	100-012	1/2"
------------	-------	---------	------

SKRUEUTTREKKERSETT

BEST.NR.	ANTALL DELER	FOR SKRUER
----------	--------------	------------

3500/2	6	4 - 20 mm
--------	---	-----------

AVTREKKERVERKTØY

AVDRAGERSETT

Et flott avtrekkersett med ekstra slanke ben som gjør det svært velegnet der det er trangt om plassen.

Inneholder både 2 og 3 armet travers med spennvidde 130mm.

Benlengder er 100, 200 og 250mm.

Leveres i solid koffert.



SMP-207614

AVDRAGERSETT HYDRAULISK

Et omfattende og innholdsrikt sett med 2 og 3-armet avdrager med ben i 3 forskjellige lengder.

Settet inneholder også 1 stk avtrekker-plate, samt hydraulisk spindel med kapasitet 12 tonn.



BEST.NR.

BENLENGDE

KAPASITET MIN.

KAPASITET MAKS.

SMP-YC-709

100 mm

45 mm

150 mm

150 mm

90 mm

230 mm

200 mm

110 mm

265 mm

AVDR.PLATE

STD.BEN

FORL.BEN

20 - 105 mm

185 mm

235 mm

AVDRAGERSETT VISKEARMER

Meget innholdsrikt sett med hele 8 stk. adaptere, som dekker de aller fleste kurante bilmodeller.

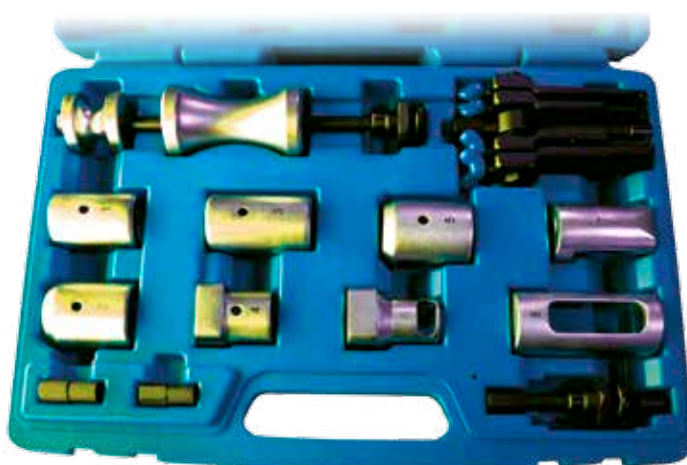

SMP-842018

AVDRAGERSETT

For bruk innvendig på lageret. Settet inneholder 5 stk. ekspanderende avtrekkere med kapasitet 8- 34mm.

Det medfølger både slagavtrekker og avtrekkerbro med 2 ben.



SMP-102900

INDUKSJONSVARMER



**Sikkert !
Effektivt !
Stor tidsbesparing !**